

Hudson Reed

Mitigeur lavabo monotrou

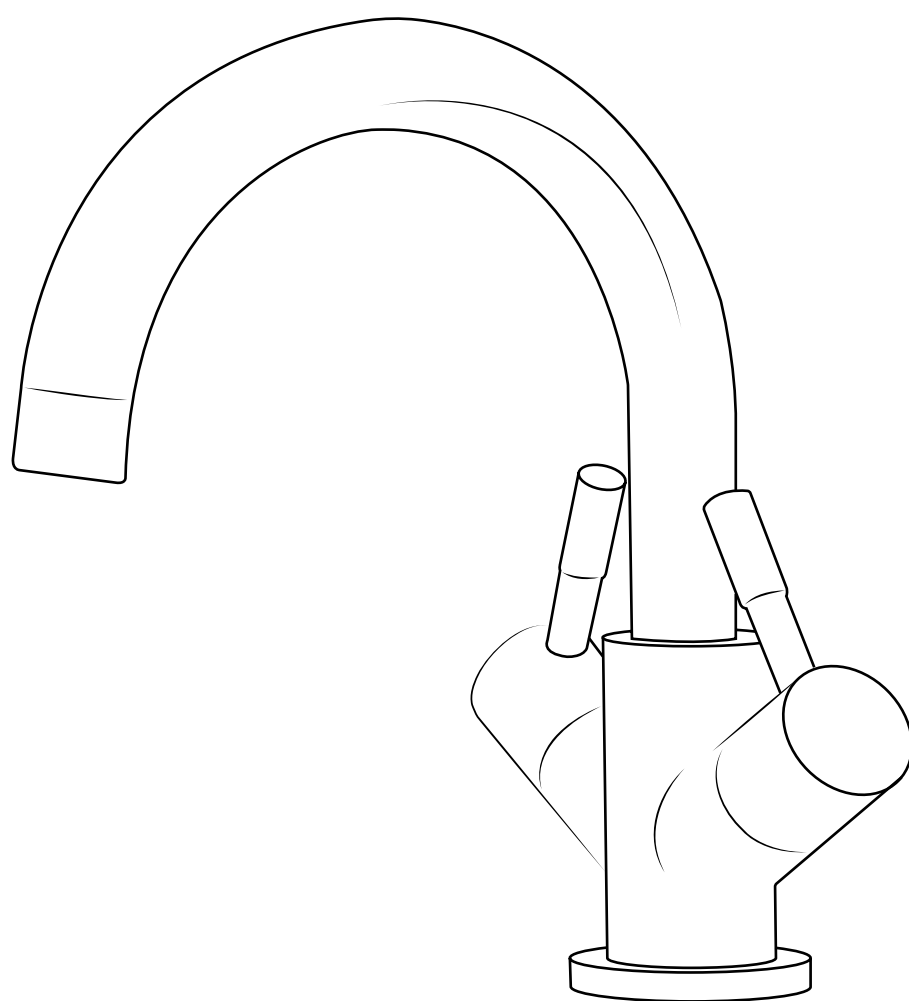

Guide d'installation

Installation

Outils nécessaires à l'installation :

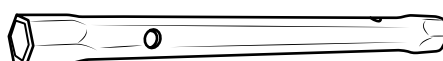
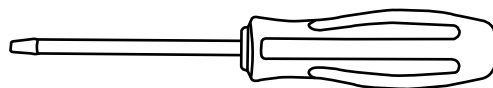
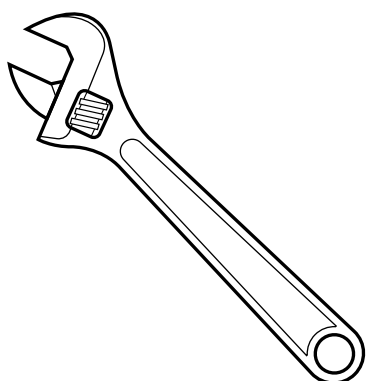

Pièces fournies :

 Le style peut varier

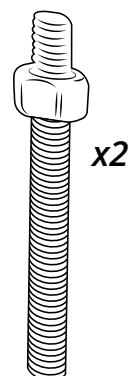
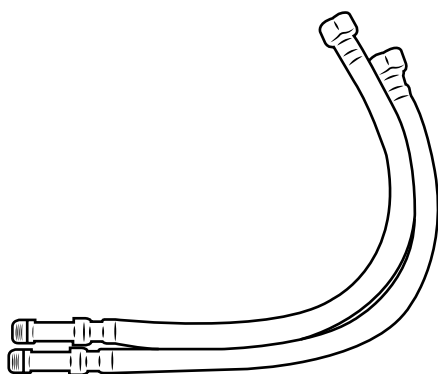
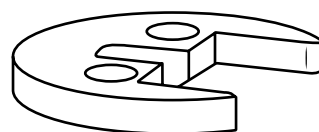
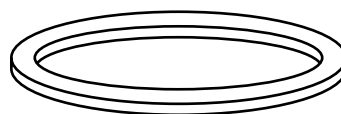
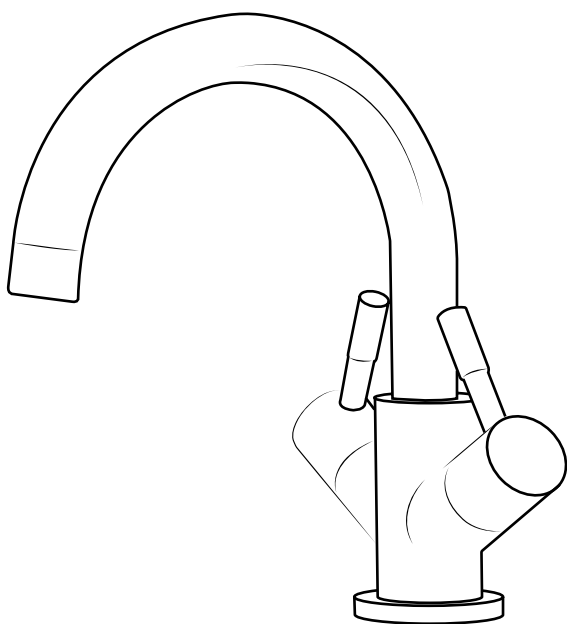

1

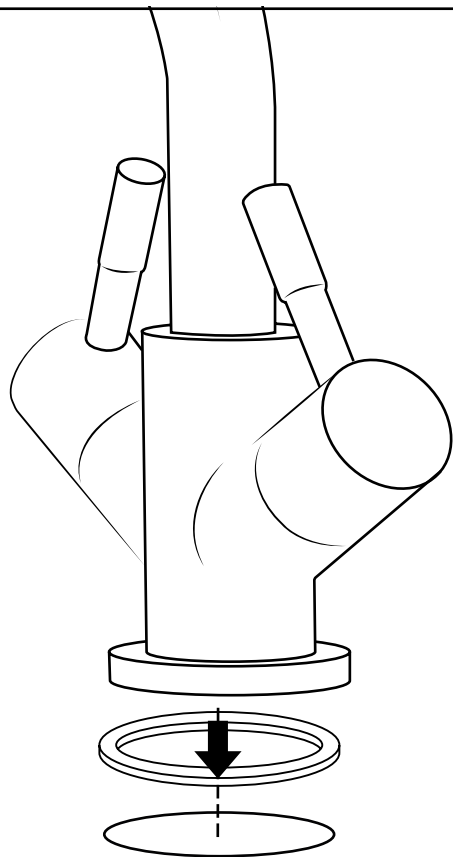

N'oubliez pas d'installer le joint torique ou la rondelle entre le corps du mitigeur et l'appareil sanitaire

2

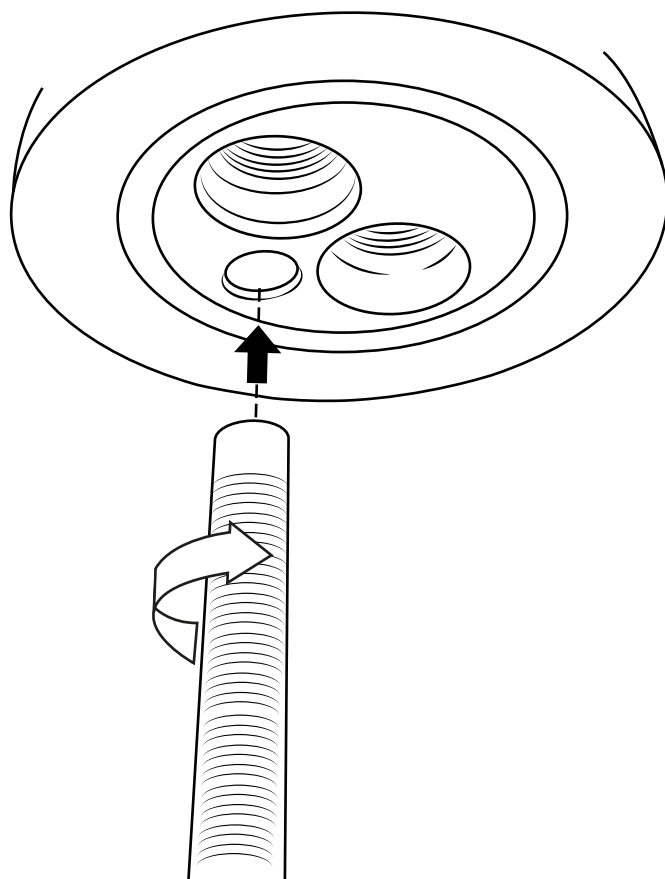

3

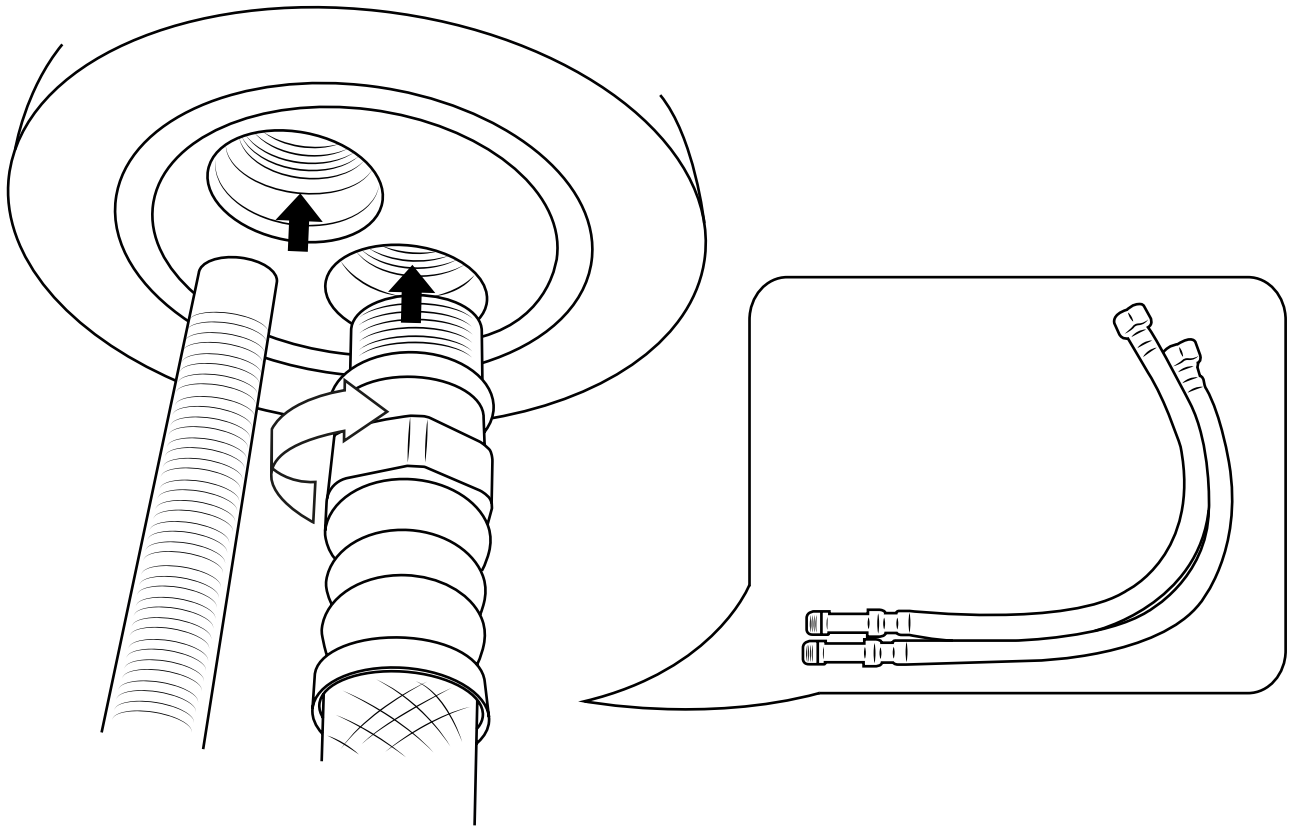

4

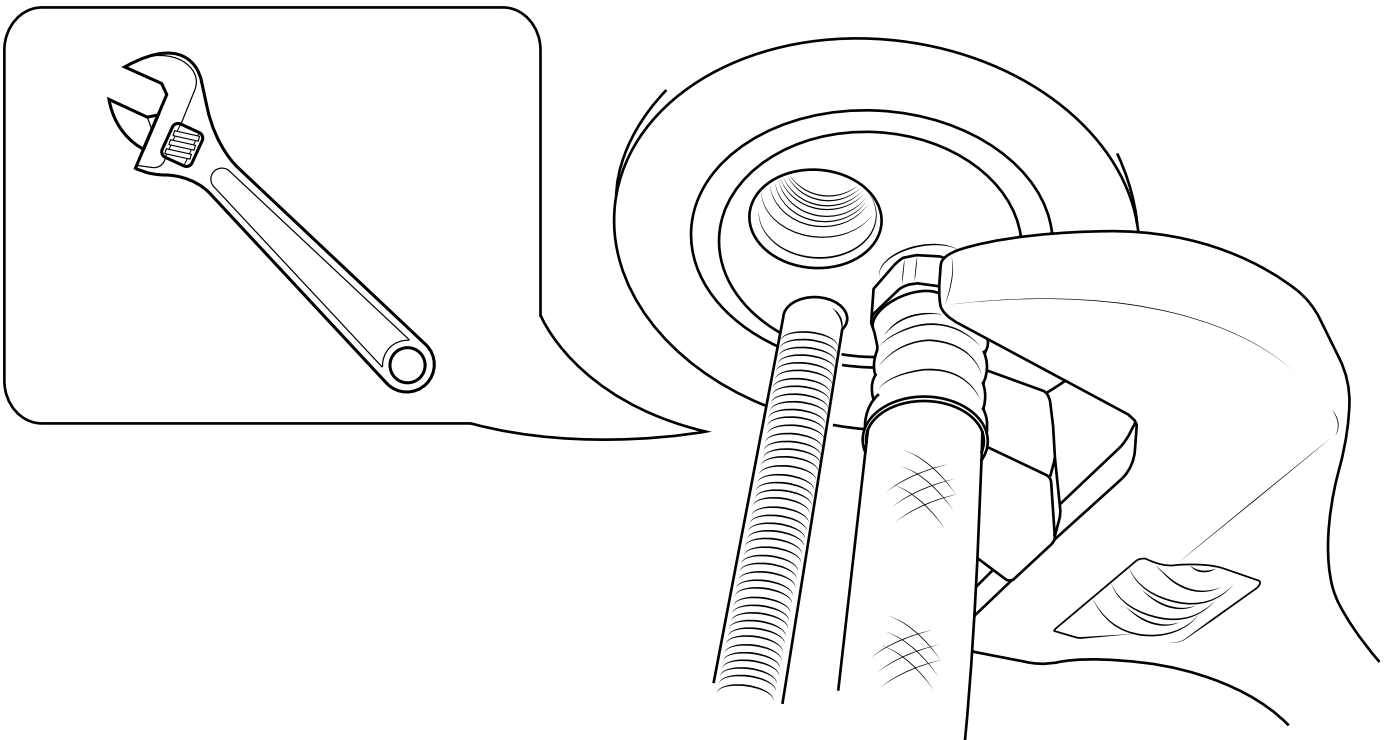

5

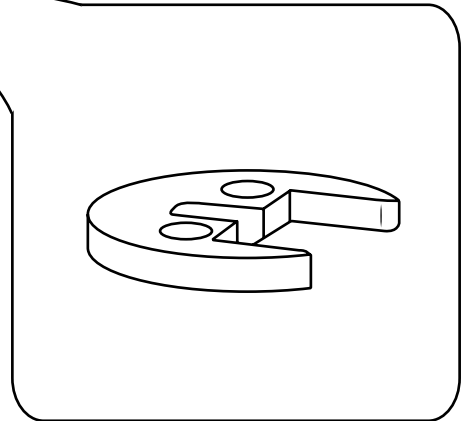
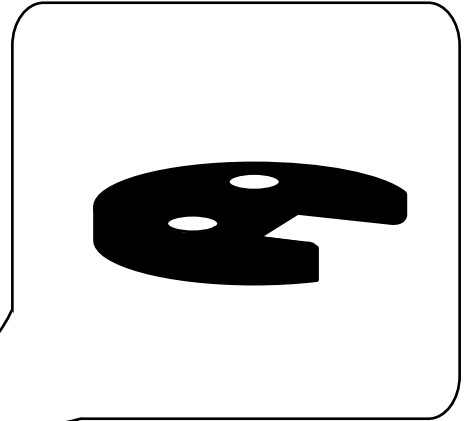
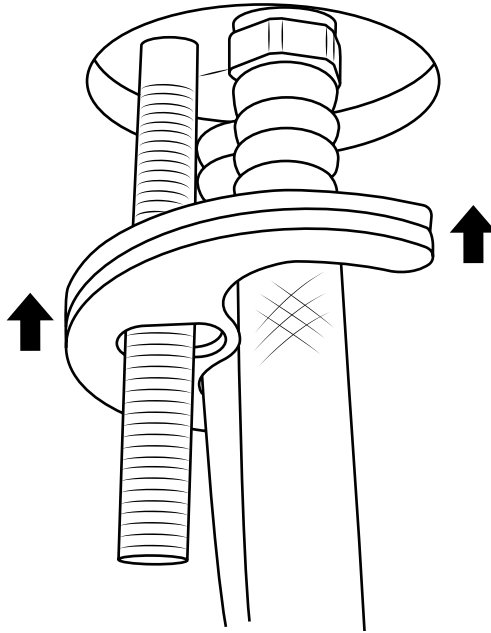
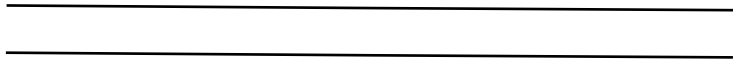

6

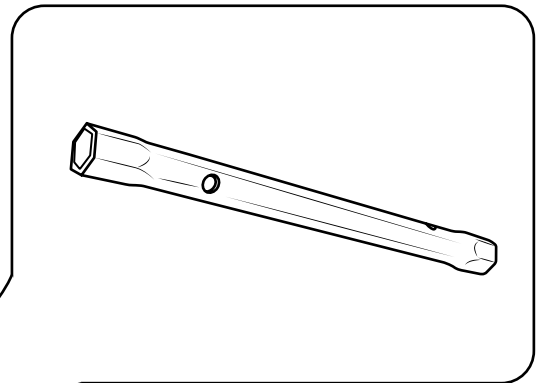
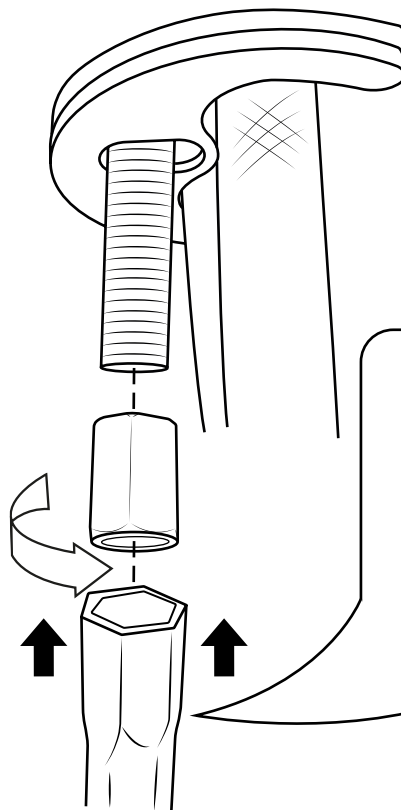
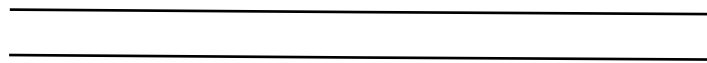

7

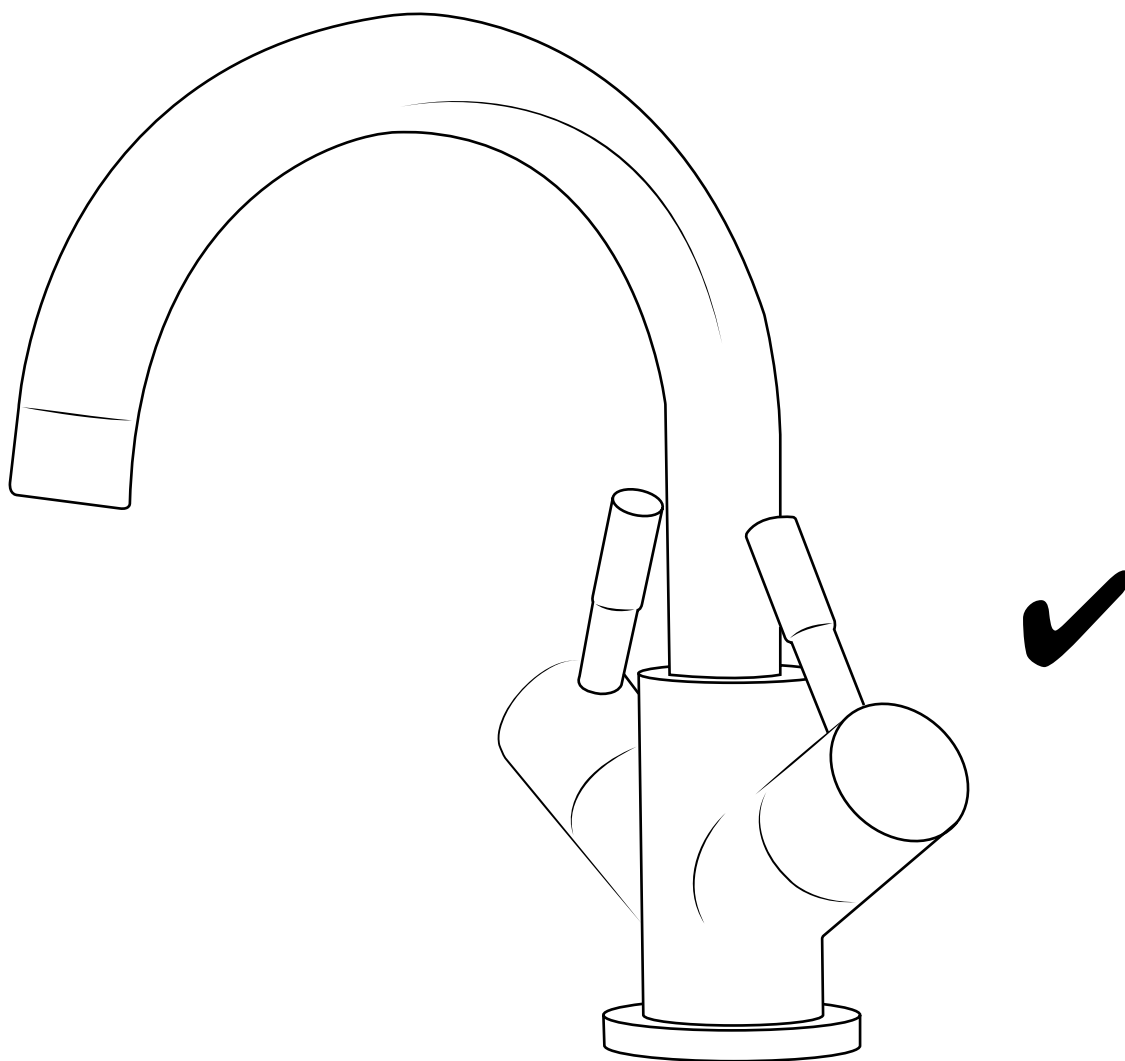

Si vous avez besoin d'informations supplémentaires ou si vous avez des problèmes avec ce produit, merci de vous référer à notre site web.